

SERVICE BULLETIN

Installation instructions for upgrade kit 912 iS Sport for ROTAX® engine type 912 i (Series)

ATA System: 73-00-00 Fuel System

OPTIONAL

Symbols used:

Please, pay attention to the following symbols throughout this document emphasizing particular information.

General note



Identifies an instruction which, if not followed, may cause serious injury or even fatal injury.



Identifies an instruction which, if not followed, may cause minor or moderate injury.



Denotes an instruction which if not followed, may severely damage the engine or could lead to suspension of warranty.

ENVIRONMENTAL NOTE

Environmental notes give you tips on environmentally conscious behaviour.

NOTE: Information useful for better handling.
 | A revision bar outside of the page margin indicates a change to text or graphic.

To obtain satisfactory results, procedures specified in this publication must be accomplished with accepted methods and prevailing government regulations.

BRP-Powertrain GmbH & Co KG. cannot be responsible for the quality of work performed in accomplishing the requirements of this publication.

1) Planning information

1.1) Applicability

All versions of the engine type:

Engine type	Serial number
912 iS	from S/N 4 417 001 up to S/N 4 417 400 inclusive
	from S/N 7 703 001 up to S/N 7 703 143 inclusive

d05819.fm

SERVICE BULLETIN

1.2) Concurrent ASB/SB/SI and SL

In addition to this Service Bulletin the following additional Service Instructions must be observed and complied with:

- SI-912 i-002, "B.U.D.S. Aircraft Installation Instruction", current issue
- SI-912 i-003, "B.U.D.S. Aircraft Update", current issue

1.3) Reason

In course of continuous development engine modification, an optimization of torque curve will be done.

1.4) Subject

Installation instruction for upgrade kit 912 iS Sport für ROTAX® engine type 912 i (Series).

1.5) Compliance

None

1.6) Approval

The technical content of this document does not relate to EASA CS-E approved engine, so this is not DOA-relevant for the engine manufacturer.

NOTE: Due to the engine type modification and tuning of the engine torque, possibly adaptation of the type certificate of the aircraft is required.

1.7) Labor time

Engine installed in the aircraft - - - labor time will depend on installation and therefore no estimate is available from the engine manufacturer.

Engine removed from the aircraft - - - approx 8 h per unit.

1.8) Mass data

Change of weight - - none.

Moment of inertia- - - unaffected.

1.9) Electrical load data

No change.

1.10) Software accomplishment summary

Upgrade of the ECU software from 912 iS to 912 iS Sport is necessary.



WARNING

Non-compliance with these instructions could result in engine damages, personal injuries or even fatal injury!

Use only ECU units with ROTAX® part no. 665568 (or explicitly by ROTAX® released ECU versions) for the engine type ROTAX® 912 iS Sport.

Engine operation with an other and/or ECU unit may result in severe engine damage!

SERVICE BULLETIN

1.11) References

In addition to this technical information refer to current issue of

- Operators Manual (OM)
- Illustrated Parts Catalog (IPC)
- Installation Manual (IM)
- Maintenance Manual (MM) Heavy
- Maintenance Manual (MM) Line

NOTICE

The change listed for checking of the overload clutch in Appendix A compared to the current issue of Maintenance Manual (Line) must be observed at the time of the approval of this Service Bulletin.

NOTE:

The status of Manuals can be determined by checking the table of amendments of the Manual. The 1st column of this table is the revision status. Compare this number to that listed on the ROTAX[®] WebSite: www.FLYROTAX.com. Updates and current revisions can be downloaded for free.

1.12) Other Publications affected

The following documentations will become effective with this Service Bulletins. The replacement pages have to be incorporated without delay in the respective documentation of the aircraft manufacturer.

Description	part no.	Issue	Date	Rev.	Chapter	Page
Operators Manual 912 i Series	898740	1	10.09.2012	1	-	-
Installation Manual 912 i Series	898647	1	10.09.2012	1	73-00-00	-

1.13) Interchangeability of parts

- All parts are interchangeable.
- At exchange take care of the following: The height of the airbox (ROTAX[®] part no. 667411) has been amended compared to the 912 iS (ROTAX[®] part no. 667410) configuration approx. 30 mm (1.14 in.).
- All affected parts cannot further be used and have to be returned F.O.B to a ROTAX[®] Authorized Distributors or their Service Center.

2) Material Information

2.1) Material- cost and availability

Price, availability and any possible support will be provided on request by ROTAX[®] Authorized Distributors or their Service Center.

2.2) Company support information

- All parts are supplied free of charge.
- Replace parts must be returned F.O.B to ROTAX[®] Authorized Distributors or their Service Center.
- This exchange program and cost sharing is valid until October 31st 2014. Up to this date application for limited reimbursement of costs can be made.

SERVICE BULLETIN

- Shipping costs, downtime costs, loss of income, telephone costs etc. or costs of conversion to other engine versions and additional work, as for instance simultaneous engine overhauls are not covered in this scope and will not be borne or reimbursed by ROTAX®.

2.3) Material requirement per engine

Parts requirement:

New part no.	Qty /engine	Description	Old part no.	Application
881521	1	912 iS Sport upgrade kit		Engine type 912 iS
composed of:				
667411	1	Airbox	-	Engine type 912 iS
667401	1	Intake manifold 1/3	-	Airbox
667406	1	Intake manifold 2/4	-	Airbox
460421	2	Connection fitting	-	Airbox
953093	4	1-ear-clamp 66,3-69,5 mm	-	Airbox
651780	1	Connector bracket	-	Support for wiring harness
951562	1	Connector bracket	-	
840671	1	Hose nipple M6	-	
440164	7	Hex./Torx-flange screw M6x16	-	Throttle body
864380	1	Double ignition coil 1 assy.	-	Intake manifold
864382	1	Double ignition coil 2 assy.	-	Intake manifold
864384	1	Double ignition coil 3 assy.	-	Intake manifold
864386	1	Double ignition coil 4 assy.	-	Intake manifold
960631	1	Tube 60 +/- 3 mm	-	
850090	4	Isolating flange	-	Intake manifold
440207	8	Hex./Torx-flange screw M6x20	-	Intake manifold
860040	2	Damper right	-	Intake manifold
860042	2	Damper left	-	Intake manifold
251691	2	Cable clamp 12/M6	-	Intake manifold
840391	2	Allen screw M6x14 DIN 912	-	Throttle body
945751	2	Lock washer A6-FST. DIN 128	-	Throttle body
953020	3	Separating plate	-	Throttle body
850020	1	Rubber ring	-	Throttle body
230415	2	Gasket ring A 6x10 DIN 7603	-	
827968	1	Washer 6.4-140HV-A2 DIN 9021	-	Support for intake silencer
842042	1	Locking nut M6 A2 DIN 985	-	Support for intake silencer
945750	8	Lock washer A5-FST DIN 128	-	Heat shield

d05819.fm

SERVICE BULLETIN

441341	8	Allen screw M5x20 DIN 912	-	
866718	8	Cable ties 94x2.5 mm	-	Spark plug connector
860734	3	Glass fiber-silicon sheating 120	-	Ignition cable
866718	2	Cable ties 94x2.5 mm	-	Fuel pressure regulator
853412	1	Cable clamp 8/M6	-	Support for fuel line
250640	6	Gasket ring A 12x18 DIN 7603	-	Fuel connection line
866716	5	Cable ties 203x7.6 mm	-	Wiring harness fixation
866714	7	Cable ties 142x3.2 mm	-	Wiring harness fixation
945750	12	Lock washer A5-FST DIN128	-	Heat shield
939445	4	Spring washer 12x5.2x0.5	-	Cover
945751	1	Lock washer A6-FST DIN 128	-	Support for fuel line
951490	2	Connector bracket	-	
866716	2	Cable ties 203x7.6 mm	-	
241239	1	Allen screw M6x16 DIN 912	-	Support for fuel line
898801	1	ECU-update label MY15	-	ECU
996916	1	Overload clutch assy.	-	Overload clutch
926035	2	Ring half	-	Overload clutch
827992	1	Thrust washer 33.2/51/1.2	-	Overload clutch
-	1	Type plate	-	Engine type 912 iS Sport

2.4) Material requirement per spare part

None

2.5) Rework of parts

None

2.6) Special tooling/lubricant/adhesives/sealing compound

Price and availability

Price and availability will be supplied on request by ROTAX® Authorized Distributors or their Service Centers.

Description	Part no.	Application
LOCTITE 243	897651	Throttle body, Double ignition coil, Support fuel line
LOCTITE 5910	899791	Overload clutch

NOTICE

In using these special tools observe the manufacturers specifications.

d05819.fm

SERVICE BULLETIN

3) Accomplishment / Instructions

Accomplish-ment NOTE: Before maintenance, review the entire documentation to make sure you have a complete understanding of the procedure and requirements.
All measures must be implemented and confirmed by at least one of the following persons or organization:

- ROTAX® - Distributors or their Service Center
- Persons with approved qualifications to the corresponding engine type. Only certified technicians (iRMT, Level Heavy maintenance) are qualified to work on these engines.

Safety notice NOTE: All work has to be performed in accordance with the relevant Maintenance Manual.



WARNING

Proceed with this work only in a non-smoking area and not close to sparks or open flames. Switch off ignition and secure engine against unintentional operation. Secure aircraft against unauthorized operation. Disconnect negative terminal of aircraft battery.



WARNING

Risk of scalds and burns! Allow engine to cool sufficiently and use appropriate safety gear while performing work.



NOTICE

Should removal of a locking device (e.g. lock tabs, self-locking fasteners, etc.) be required when undergoing disassembly/assembly, always replace with a new one.

ASTM Compliance **With the upgrade from an 912 iS engine to the 912 iS Sport configuration the ASTM compliance will be dissolved.**

Before and after retrofitting a configuration- and performance test of the engine must be carried out. Prior accomplishing the upgrade, contact your authorized ROTAX® distributor to obtain more information on the re-establishment of ASTM compliance for your engine and to request the required "Configuration and performance verification for accomplishing ASTM Compliance for retrofitted ROTAX 912 iS Sport engines" form.

d05819.fm

SERVICE BULLETIN

3.1) Upgrade kit part no. 881521 912 iS Sport

Graphic

Scope of delivery



Part	Function
1	Packing case
2	Parts lists
3	Upgrade kit 912 iS Sport

Fig. 1

08257,08258,08259

d05819.fm

SERVICE BULLETIN

3.2) Exchanging of the Overload clutch

See Fig. 2.

NOTICE

Part number of the gearbox must be changed.
 From part no. 893340 to 893341 and/or
 part no. 893345 to 893346.

Step	Procedure
1	The exchange of the overload clutch must be done according to the information in the latest Maintenance Manual Heavy for the respective engine type.
2	Due to the exchange, the ROTAX part no. of the gearbox must be adapted. The engraved ROTAX part no. on the gearbox housing must be marked as invalid. In addition, the new ROTAX part no. must be worked into the surface (electric pen, figure stamps or similar).

Graphic

Fig. 2



1 Part number for Gearbox

00261

3.3) Disassembly Airbox

The disassembly must be done according to the information in the latest Maintenance Manual Heavy for the respective engine type.

3.3.1) Removal of the Fuel hoses and Governor

NOTICE

Fuel pressure 3 bar (43.51 psi). Make fuel hoses nonpressurized.

See Fig. 3.

The following steps are necessary:

Step	Procedure
1	Cut off the complete connection for propeller (Governor) according to the instructions of the aircraft manufacturer.
2	Remove the fuel hoses according to the instructions of the aircraft manufacturer. NOTE: Mark fuel hoses (inlet/outlet).

d05819.fm

SERVICE BULLETIN

Graphic

Fig. 3



1 Fuel hoses

08260

08261

3.3.2) Removal of the Overflow bottle

See Fig. 4.

The following steps are necessary:

Step	Procedure
1	Remove venting hose with overflow bottle.

Graphic

Fig. 4



1 Venting hose

08262

3.3.3) Removal of the Type plate und removal of the ASTM Label

- The Typ plate on the crankcase must be removed and sent to the ROTAX® authorized distributor.

3.3.4) Removal of the Air filter and Throttle body assy.

See Fig. 5 to Fig. 7.

d05819.fm

SERVICE BULLETIN

The following steps are necessary:

Step	Procedure
1	Unplug the connector (2) from the throttle potentiometer.
2	Remove the air filter and air intake hose (delivered by manufacturer) from the throttle body assy in accordance with the aircraft manufacturer.

Graphic

Fig. 5

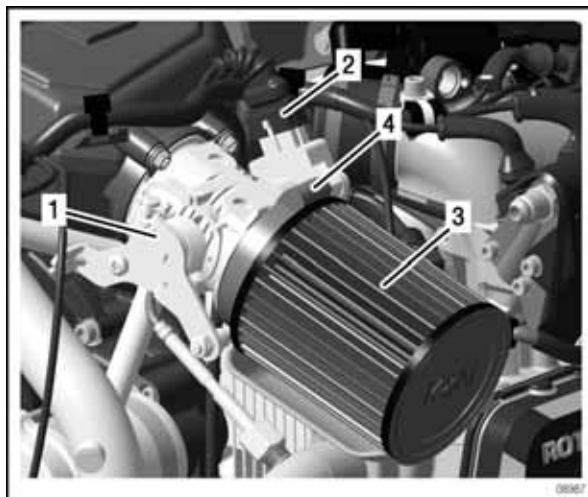

- 1 Throttle body assy.
- 2 Connector
- 3 Air filter
- 4 Screw hose clamp

Step	Procedure
3	Remove the throttle cable from the throttle body.
4	Loosen 3 M6x12 hex./torx collar screws with the separating plate. NOTE: They are adhered with LOCTITE 243!

Fig. 6

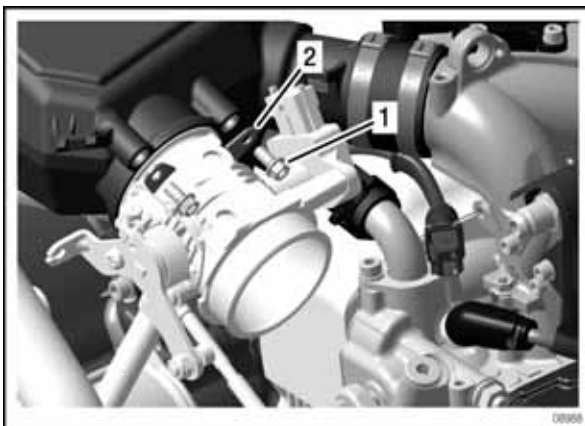

- 1 M6x12 hex./torx collar screws
- 2 Separating plate

SERVICE BULLETIN

NOTICE

Do not lose the rubber gasket ring and ensure that it does not remain in the airbox.

Step	Procedure
5	Remove the throttle body and the rubber gasket ring.

Fig. 7

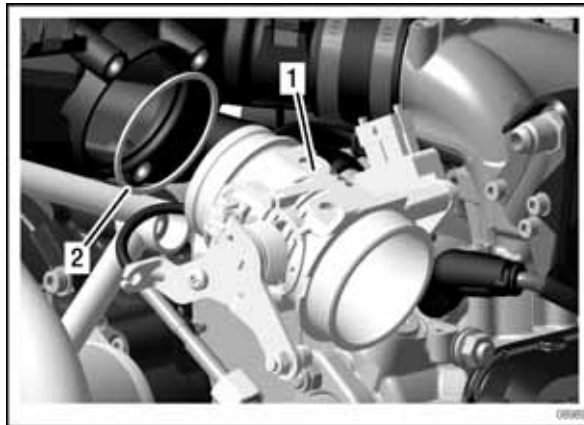

- 1 Throttle body
- 2 Rubber gasket ring

SERVICE BULLETIN

3.3.5) Removal Fuel line assy

See [Fig. 8](#) to [Fig. 10](#).

Graphic

Overview

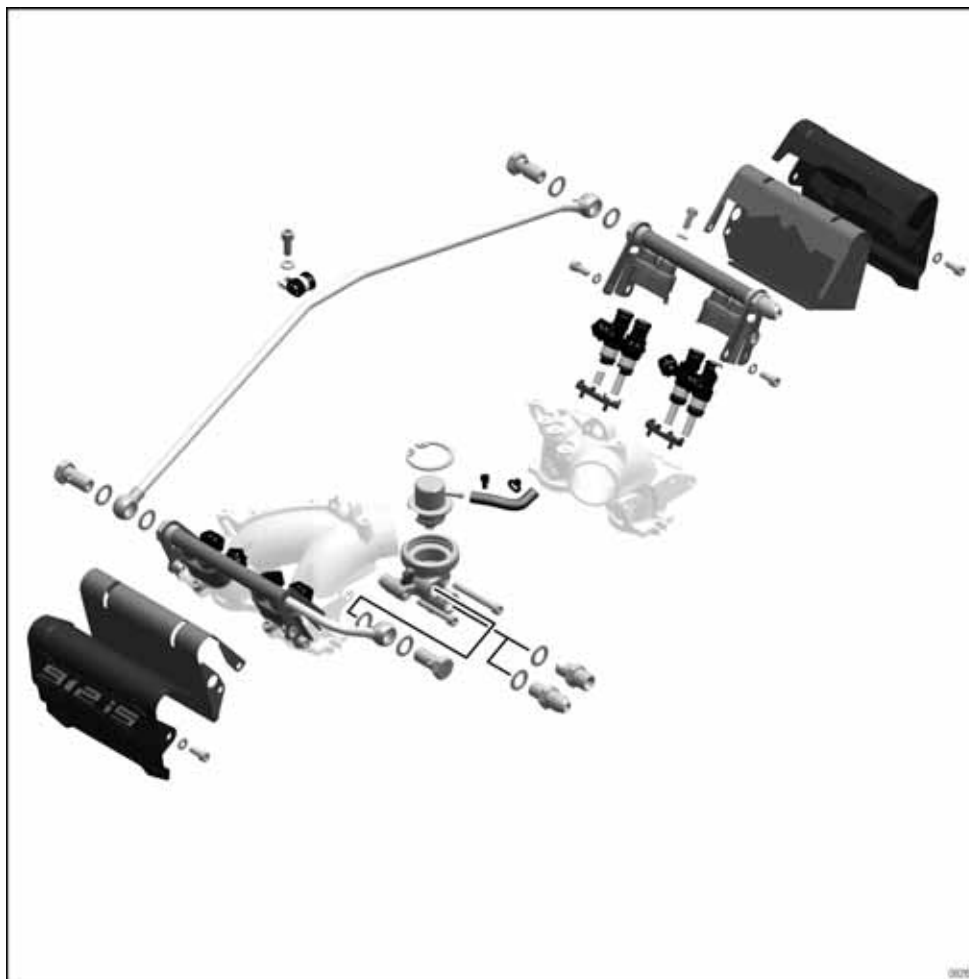

Fig. 8

The following steps are necessary:

ENVIRONMENTAL NOTE

Avoid contact of runoff fuel with soil!

Step	Procedure
1	Remove the feed line to fuel rail 1/3 and the return line to fuel rail 2/4 and fuel pressure regulator and close them with the appropriate caps.
2	Loosen the M6x16 Allen screw of the fuel line assy.

d05819.fm

SERVICE BULLETIN

ENVIRONMENTAL NOTE

All the operating fluids and cleaning agents can damage the environment if not disposed of properly. Dispose of operating fluids in an eco-friendly manner!

Graphic

Fig. 9

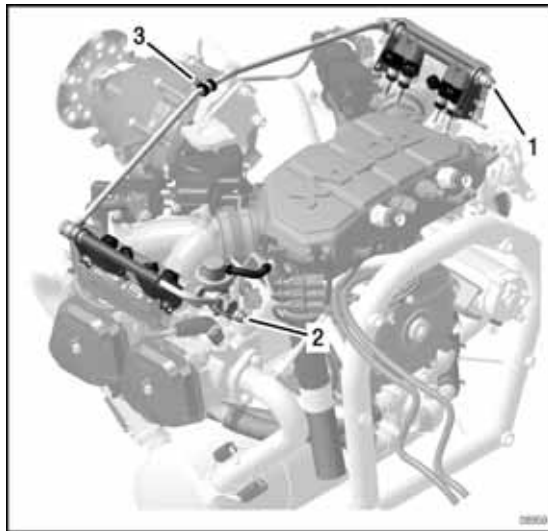

- 1 Fuel rail 1/3 feed line
- 2 Fuel rail 2/4 outlet line
- 3 M6x16 Allen screw

Fig. 10

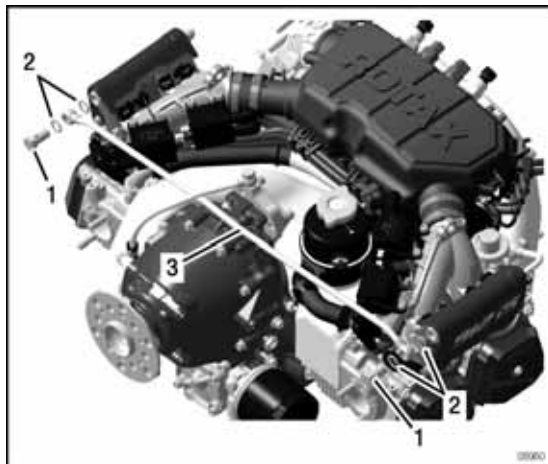

- 1 M12x1.5 banjo bolt
- 2 Gasket ring
- 3 Fuel hose assy.

Step	Procedure
3	Loosen 2 M12x1.5 banjo bolts with gasket ring.
4	Remove the fuel line assy.

d05819.fm

SERVICE BULLETIN

3.3.6) Removal Fuel pressure regulator assy.

See Fig. 11 to Fig. 13.

The following steps are necessary:

Step	Procedure
1	Remove the cable ties and pull out the hose.
2	Disconnect the plug connection to the temperature sensor.

Fig. 11

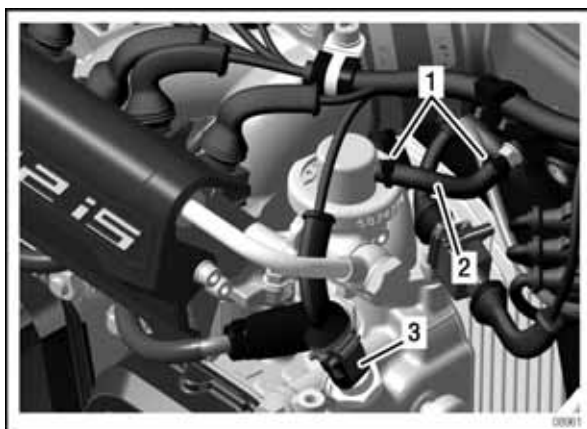

- 1 Cable ties
- 2 Hose
- 3 Temperature sensor

Step	Procedure
3	Loosen the banjo bolt with gasket ring in the pressure regulator housing.

Fig. 12

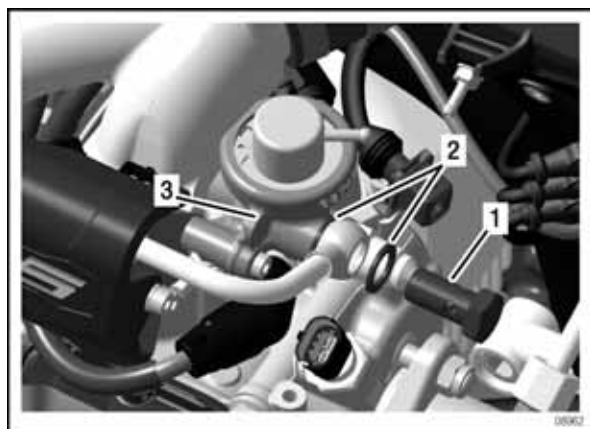

- 1 Banjo bolt
- 2 Gasket ring
- 3 Pressure regulator housing

SERVICE BULLETIN

Step	Procedure
4	Loosen the M5 Allen screws. NOTE: 1 M5x35 Allen screw. 1 M5x45 Allen screw.
5	Remove the fuel pressure regulator and housings.

Fig. 13

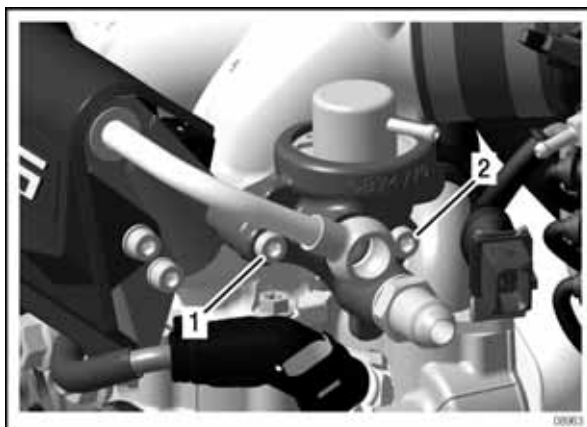

1 M5x35 Allen screw
2 M5x45 Allen screw

3.3.7) Removal Fuel rail

See Fig. 14 to Fig. 19.

The following steps are necessary:

Step	Procedure
1	Loosen 2 M5x12 Allen screws from the cover of the fuel rail.
2	Lift off the cover.

Graphic

Fig. 14



1 M 5x12 Allen screw
2 5.3 washer
3 Fuel rail cover

d05819.fm

SERVICE BULLETIN

Step	Procedure
3	Loosen 4 M5x12 Allen screws.

Fig. 15

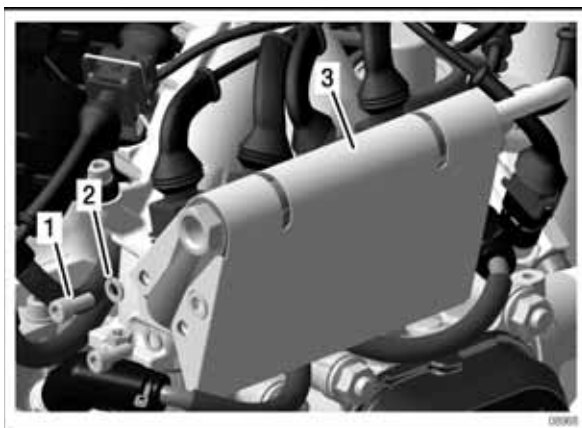

- 1 M5x12 Allen screw
- 2 washer 5.3
- 3 Heat shield

Step	Procedure
4	Lift off the head shield on both sides in the region of the rivet nut.

Fig. 16

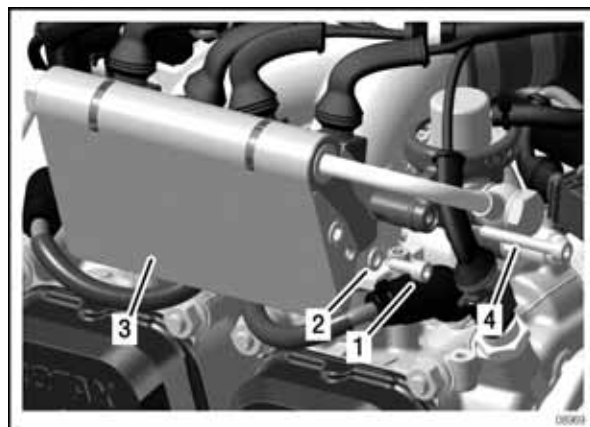

- 1 M5x12 Allen screw
- 2 5.3 washer
- 3 Heat shield
- 4 M5x35 Allen screw

Step	Procedure
5	Disconnect the injectors. NOTE: The cables are labelled INJ_1 to INJ_8.

d05819.fm

SERVICE BULLETIN

Fig. 17

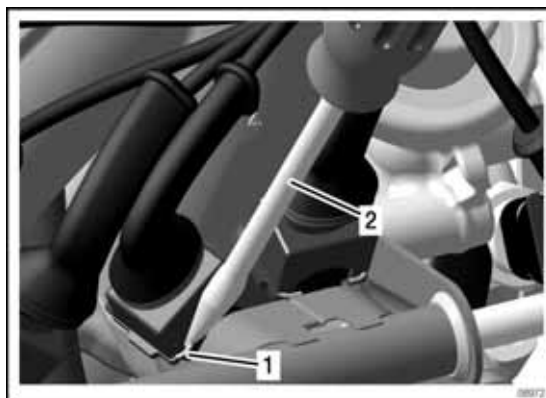
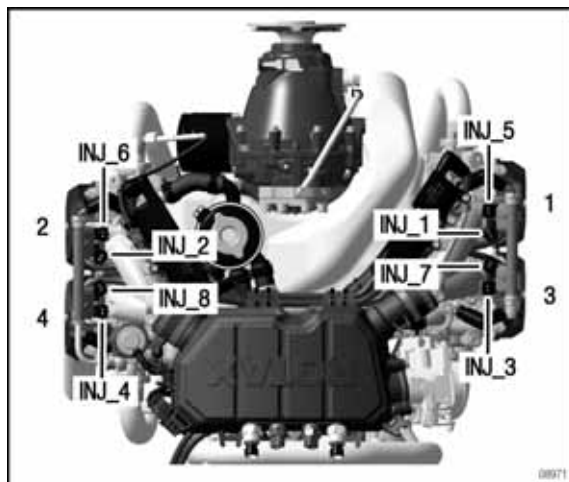

1 Injector connectors
1 Screwdriver

Step	Procedure
7	Use a screwdriver to lever out the spring clip and then unplug the connector. NOTE: Let the wire clip snap back in after the connector has been disconnected so that it does not get lost.
8	Remove the cable clamps of the wiring harness.

Fig. 18

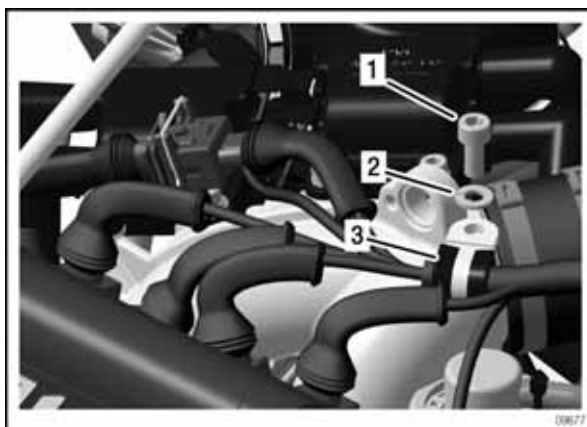

1 M6x14 Allen screw
2 6.4 washer
3 cable clamp

Step	Procedure
9	Loosen the two M5x12 Allen screws of the left-hand fuel rail (2/4) attachment and the two M5x12 Allen screws of the right-hand fuel rail (1/3) with the lock washers.
10	Remove the fuel rail on the left and right of the intake manifold.

d05819.fm

SERVICE BULLETIN

Fig. 19

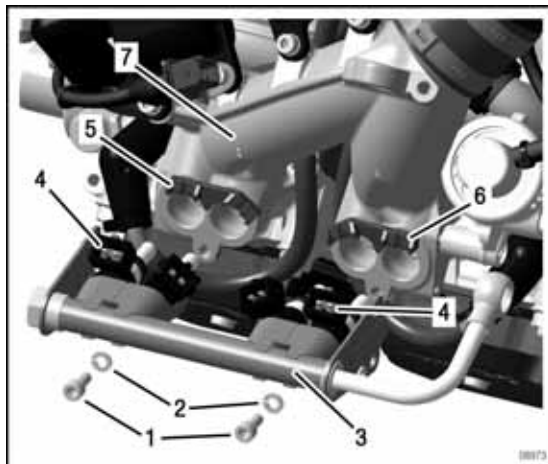

- 1 M5x12 Allen screw
- 2 DIN 128-A5-FST lock washer
- 3 Fuel rail (2/4)
- 4 Injection valve
- 5 Left muffler
- 6 Right muffler
- 7 Intake manifold

3.3.8) Removal Resistance spark plug connector and Double ignition coil

See Fig. 20 to Fig. 23.

The following steps are necessary:

Step	Procedure
1	Unscrew all 8 resistance spark plug connector.

Graphic

Fig. 20



08267

Step	Procedure
2	Disconnect 4 ignition coil connectors on each side.

SERVICE BULLETIN

Fig. 21

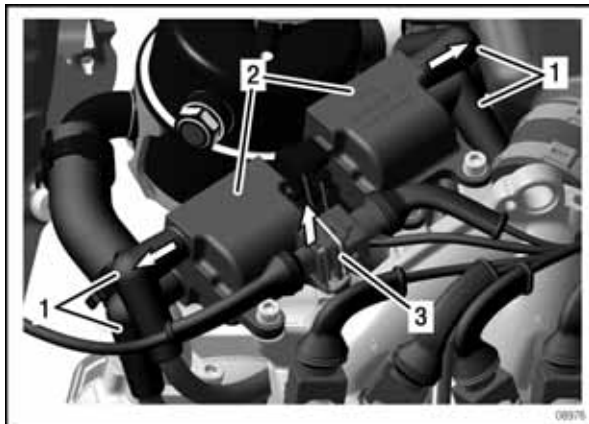

- 1 Ignition coil connector
- 2 Double ignition coils
- 3 EGT-connector

Step	Procedure
3	Carefully pull EGT1 and EGT 2 connector (cylinders 1 and 2) out of the locking plate.
4	Press the metal bracket and unplug the connectors..

Fig. 22

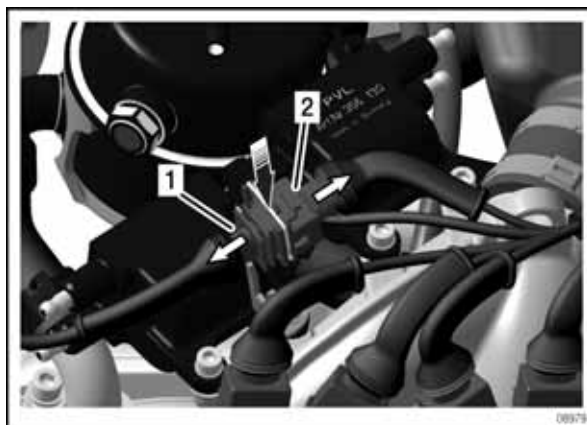

- 1 EGT-connector
- 2 Connector

Step	Procedure
5	Loosen M5x16 Allen screws with A5 lock washers.
6	Unplug the connectors to the double ignition coils.

d05819.fm

SERVICE BULLETIN

Fig. 23

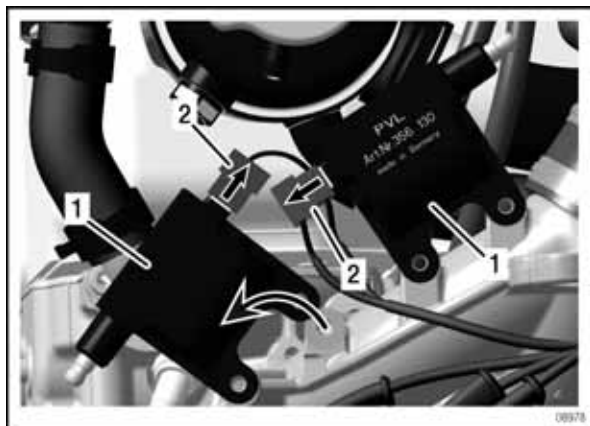

- 1 Double ignition coils
- 2 Ignition coil connector
(coil 1, coil 2, coil 3, coil 4)

3.3.9) Removal Airbox pressure sensor and Temperature sensor

See Fig. 24 to Fig. 26.

NOTE: Use tool part no. 876075 for air pressure sensor and tool part no. 876130 for temperature sensor.

Wiring harness designation:

- MAPS_1 and MATS_1 for LANE A
- MAPS_2 and MATS_2 for LANE B

Step	Procedure
1	Remove the 4 cable ties.
2	Unplug the connectors of the 2 pressure sensors.
3	Lift the latch and pull off.

Graphic

Fig. 24

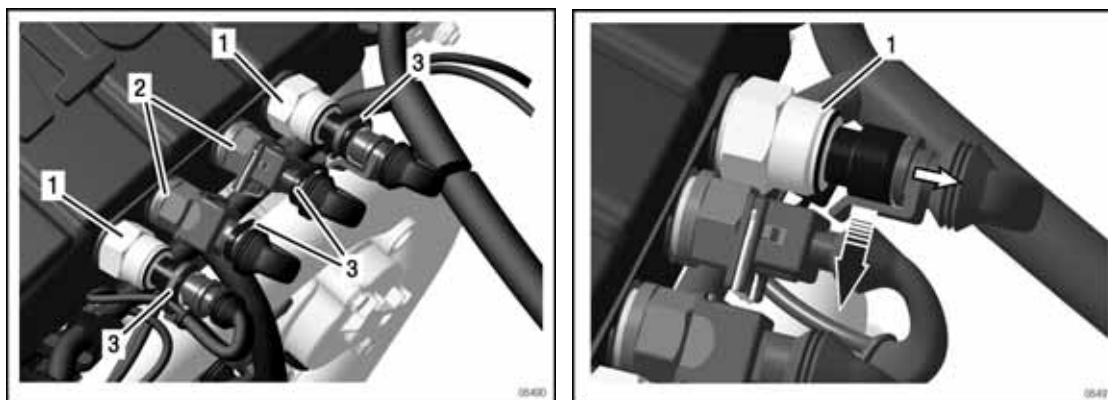

- 1 Pressure sensor
- 2 Temperature sensor
- 3 Cable ties

d05819.fm

SERVICE BULLETIN

Step	Procedure
4	Disconnect the plug connection to the 2 temperature sensors.
5	Press the metal bracket and separate the connectors.

Fig. 25

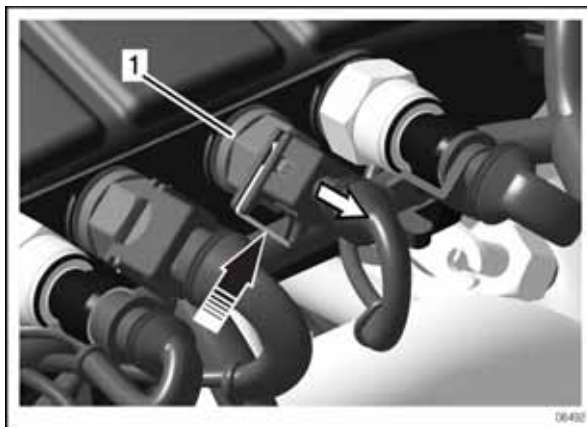

1 Temperature sensor

Step	Procedure
6	Remove the cable ties on the airbox.

Fig. 26

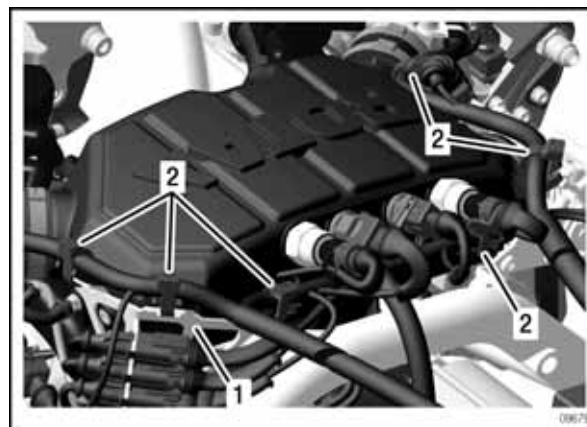

1 Airbox
2 Cable ties

3.3.10) Unplug CPS1, CPS2 and Knock sensor

See [Fig. 27](#).

Wiring harness designation:

- CPS_1 fo LANE A (yellow mark)
- CPS_2 for LANE B
- KNOCK

d05819.fm

SERVICE BULLETIN

Step	Procedure
1	Unplug CPS 1 and CPS 2.
2	Lift the latch and pull apart (KNOCK).

Fig. 27

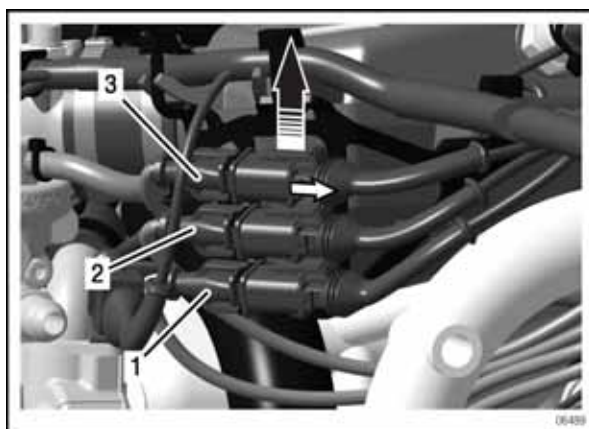

- 1 CPS_2 LANE B
- 2 CPS_1 LANA A
- 3 KNOCK knock sensor

3.3.11) Removal Airbox and Intake manifold

See Fig. 28 to Fig. 32.

The following steps are necessary:

Step	Procedure
1	Remove the cable ties.
2	Remove the support plate.

Graphic

Fig. 28

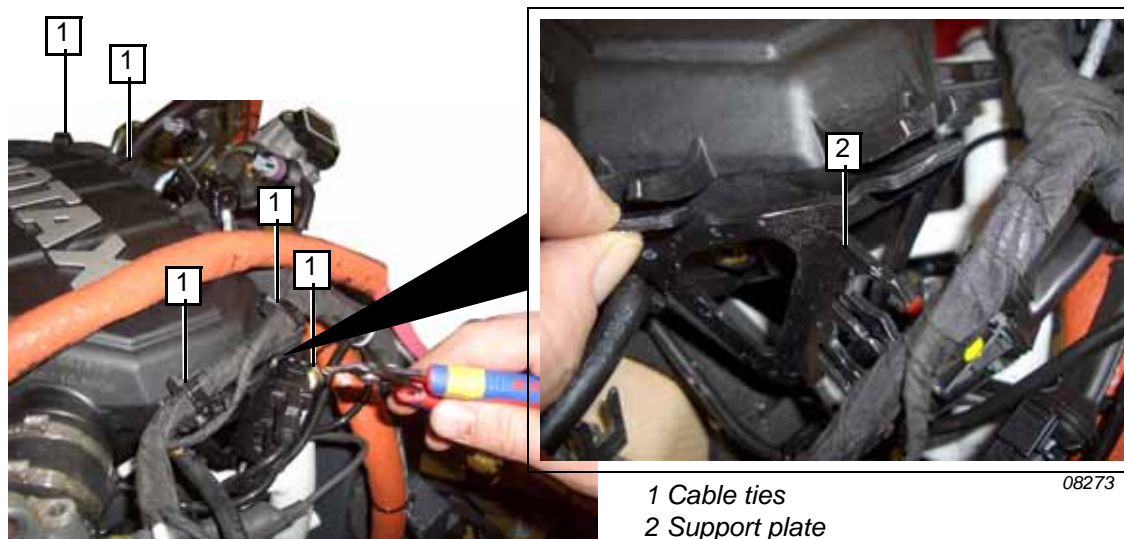

- 1 Cable ties
- 2 Support plate

08273

d05819.fm

SERVICE BULLETIN

Step	Procedure
3	Loosen the M6 hex. nut attaching the airbox to the ignition housing along with the washer.

Fig. 29

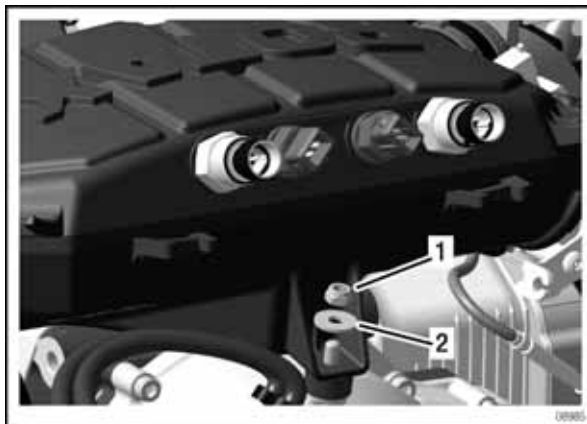

1 M6 hex. nut
2 6.4 washer

Step	Procedure
4	Loosen 4 M6 hex./torx collar screws inwards for attachment to the cylinder head 2/4.
5	Loosen the two inner hex./torx collar screws.

NOTICE

Screws cannot be completely unscrewed. To remove the screws, the intake manifold must be lifted after losing all 4 hex./torx collar screws.

NOTE: The intake manifold have ports rather than bores for the M6 hex./torx collar screws.

d05819.fm

SERVICE BULLETIN

Fig. 30

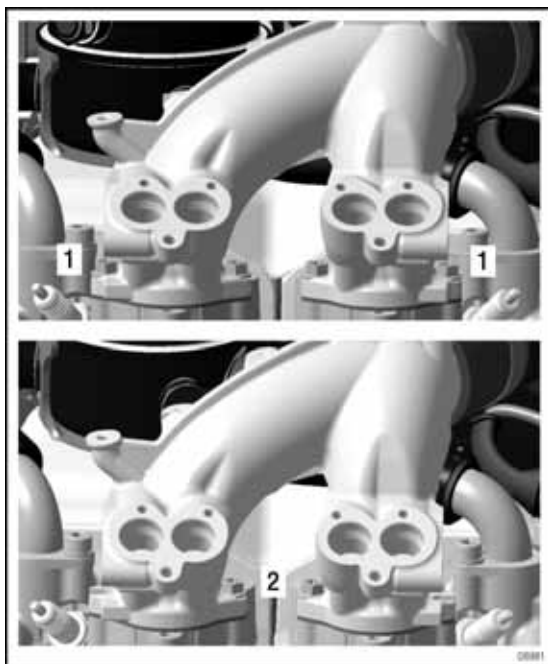

- 1 Outer screw-fastening
- 2 Inner screw-fastening

Step	Procedure
6	Remove the airbox along with intake manifold 2/4, intake manifold 1/3 and double ignition coils.
7	Remove the insulating flange of the cylinder heads.
8	Close the intake duct using a plug (part no. 860397).

NOTICE

Make sure no foreign materials get into the instake, this can even cause damage to the engine!

Fig. 31

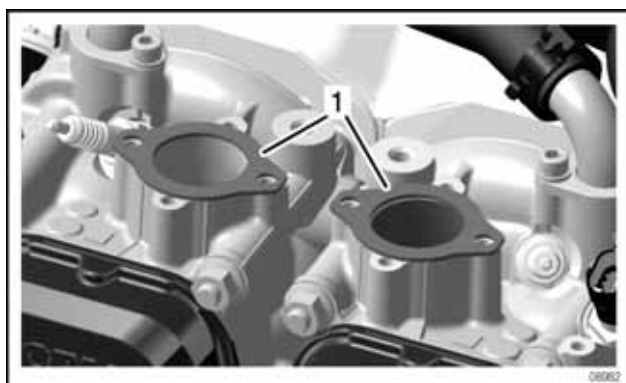

- 1 Insulating flange

d05819.fm

SERVICE BULLETIN

Fig. 32



1 Plug part no. 860397

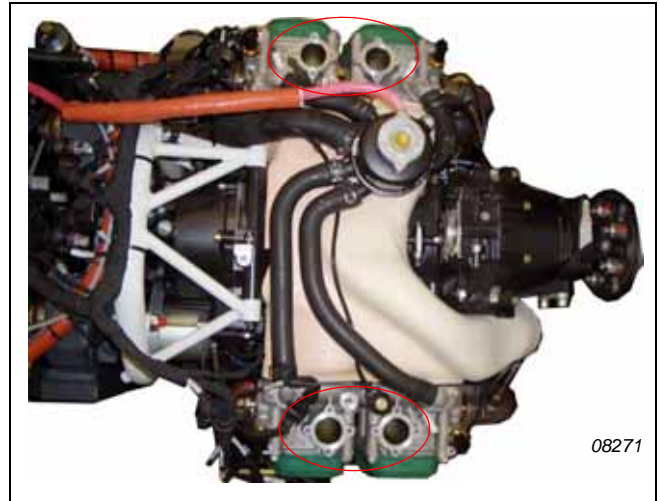

d05819.fm

SERVICE BULLETIN

3.4) Installation of the Upgrade kit 912 i Sport part no. 881521

Graphic Overview



OLD

NEW

08274

Fig. 33

08274

3.4.1) Preparation Airbox

Graphic

See Fig. 34 to Fig. 36.

The following steps are necessary:

Step	Procedure
1	Do not cut and no tighten the cable ties.

Fig. 34



1 Cable ties

08259

d05819.fm

SERVICE BULLETIN

Step	Procedure
2	Route the igniton cable correctly.
3	Peform all ignition cable in the middle.

NOTICE Push the white glass fiber-silicon hose (ROTAX part no. 860734) of the ignition cable marked with B (B=Bottom).

Step	Procedure
4	Halve glass fiber-silicone hose and mount the ignition cable that is signed with a T (T = Top, Cyl. 1T, Cyl. 3T or Cyl. 2T, Cyl. 4T). The separation point of the fiber-glass-silicone hose must be directed towards the ignition coil and placed between the intake ports. This protection hose is not shown in the following illustrations of this Service Bulletin.

NOTE: Plug this ignition cable for easier handlings in the holes for injection.
 Fig. 35

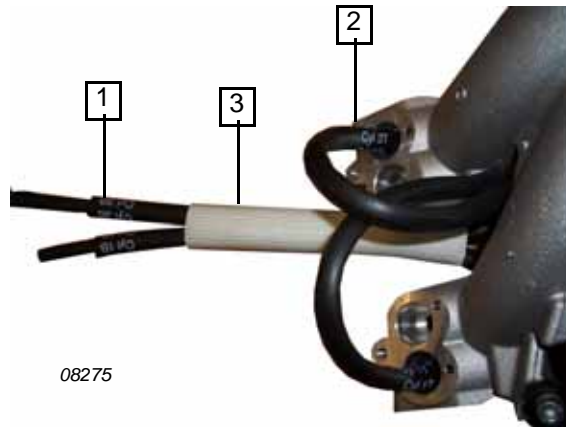

- 1 Ignition cable B = Bottom
- 2 Ignition cable T = Top
- 3 Glass fiber - silicon sheathing
- 4 Protection hose

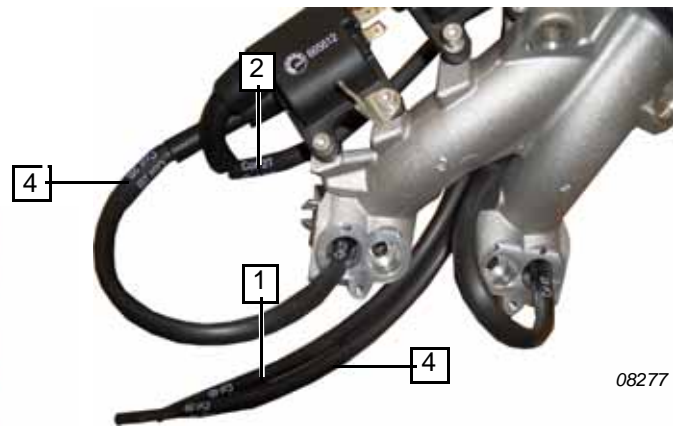
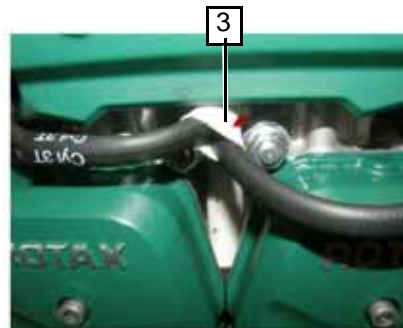

d05819.fm

SERVICE BULLETIN

NOTICE

If the protection hose of ignition cable has been removed, pay attention to the labeling at installation.

COIL = always at the ignition coil

CYL = always at the ignition spark side

NOTICE

Make sure that no impurities and foreign particles enters the intake duct.

Step	Procedure
5	Clean the contact surface on the cylinder heads.
6	Put insulating flanges on cylinder heads.

Fig. 36

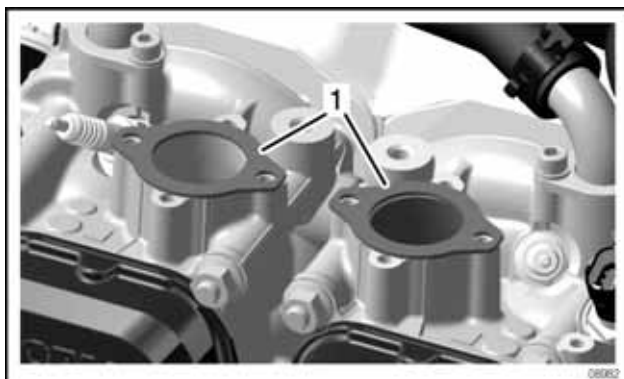

1 Insulating flange

3.4.2) Installation of the Airbox module

See [Fig. 37](#) to [Fig. 39](#).

The following steps are necessary:

Step	Procedure
1	Position the airbox including intake manifold on the engine.
2	Thread the ignition cable for the lower spark plugs between the cylinder heads. NOTE: The insulating flange is pre-pressed.

NOTICE

Do not squeeze any ignition wiring!

SERVICE BULLETIN

Graphic

Fig. 37

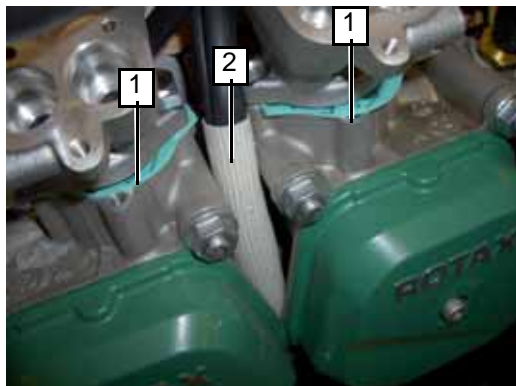

1 Insulating flange
2 Ignition cable

08279

Step	Procedure
3	Install airbox with a new hex. nut M6 on ignition housing and do not tighten.

Fig. 38

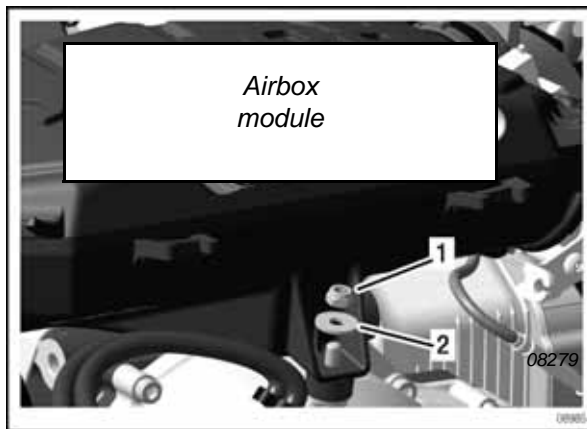

1 Hex. nut M6 DIN 924
2 Washer 6.4

08279

Step	Procedure
4	Screw in 8 hex./torx-flange screws into the intake manifold 2/4, 1/3. Make sure that the gasket does not slip.

NOTICE

Do not tighten the hex./torx flange screws yet. Only tighten when the fuel line assy. is pre-assembled. To allow stress-free alignment of the unit.

d05819.fm

SERVICE BULLETIN

Fig. 39

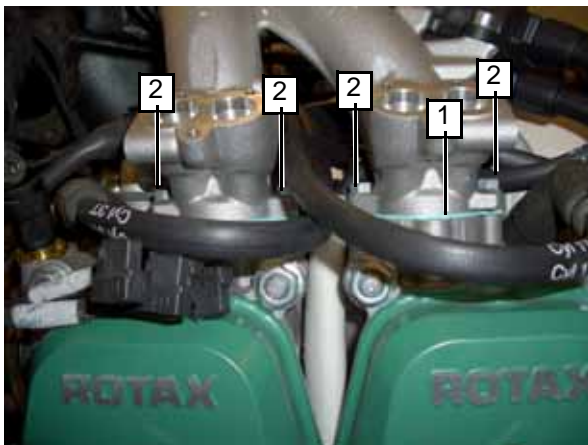

- 1 Isolating flange
- 2 Hex./Torx-flange screws M6x20

08279

3.4.3) Installation of the Spark plug connectors

See Fig. 40.

The following steps are necessary:

Step	Procedure
1	Install spark plug connectors using 8 pcs. cable ties part no. 866718. NOTE: Make sure that the ignition cables are properly routed and connected.

Graphic

Fig. 40



08280



08281

SERVICE BULLETIN

3.4.4) Installation of the Injection valves left (2/4) and right (1/3)

See Fig. 41 to Fig. 43.

The following steps are necessary:

Step	Procedure
1	Install new damper left and right. NOTE: Damper left and right are different and serve for positioning and fixing of the injectors valve.

Graphic

Fig. 41

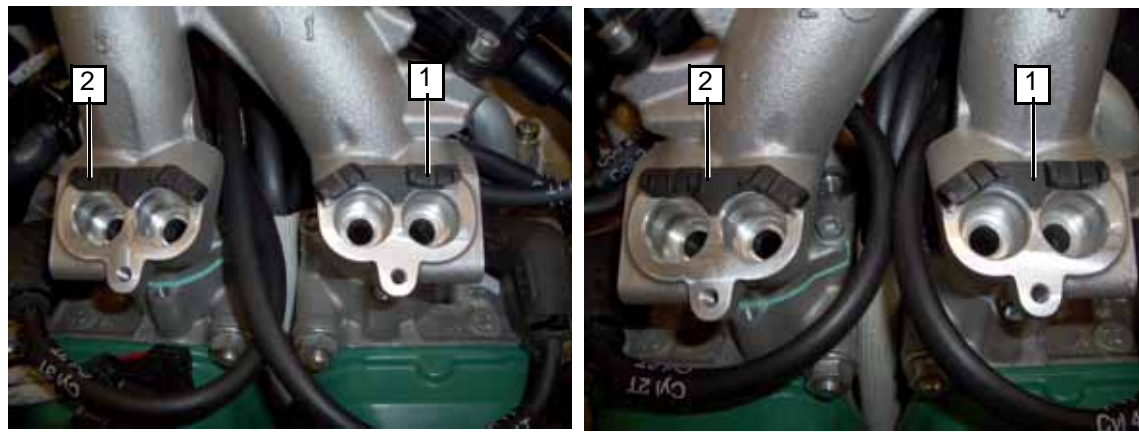

1 Damper right
2 Damper left

08282

08283

Step	Procedure
2	Lubricate O-rings of the injection valves slightly with KLUEBER ISOFLEX TOPAS Nb5051. NOTE: Perform visual inspection for damage before installation!

Fig. 42

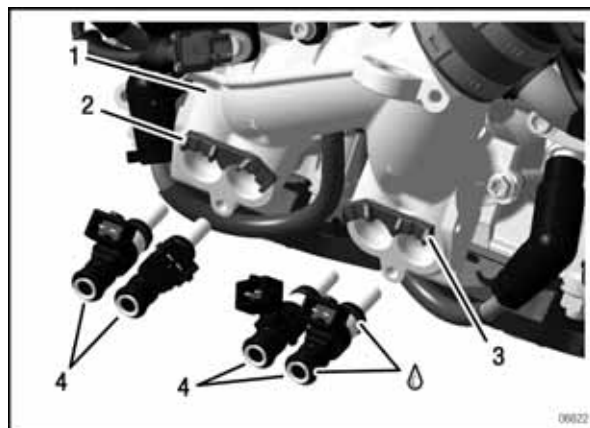

1 Intake manifold
2 Damper left
3 Damper right
4 Injection valve

d05819.fm

SERVICE BULLETIN

Step	Procedure
3	Install fuel rail left and right from intake manifold using Allen screws M5x12 with lock washers A5.

NOTICE

Use new lock washers!

Fig. 43

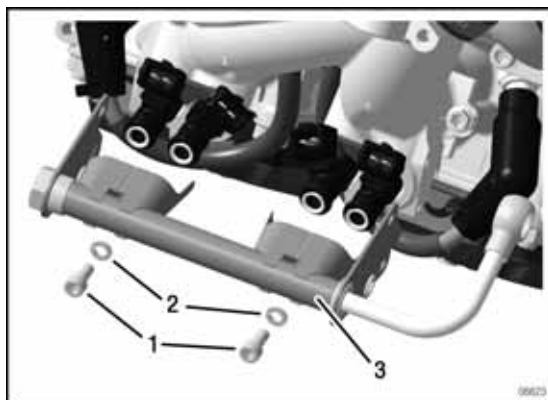

- 1 M5x12 Allen screw
- 2 Lock washer DIN 128-A5-FST
- 3 Fuel rail

3.4.5) Installation of the Fuel pressure regulator

See Fig. 44.

The following steps are necessary:

Step	Procedure
1	Install and tighten fuel pressure regulator assy. using M5x35 Allen screw and M5x45 Allen screw. Tightening torque 6 Nm (53 in. lb.).

NOTE: First tighten the M5x45 Allen screw. Tightening the front M5x35 Allen screw will secure the heat shield too.

Graphic

Fig. 44

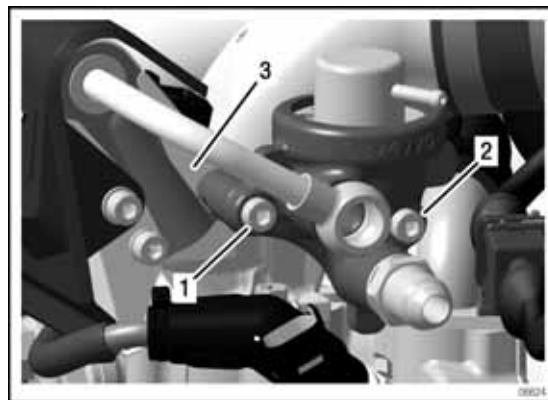

- 1 M5x35 Allen screw
- 2 M5x45 Allen screw
- 3 Heat shield

d05819.fm

SERVICE BULLETIN

Step	Procedure
2	Install banjo bolt M12x1.5x24 using two gasket rings A12x18. Tightening torque 25 Nm (221 in. lb.).
3	Tighten the Allen screws from the fuel rail. Tightening torque 6 Nm (53 in. lb.).

3.4.6) Installation of heat shield and/or Cover

See Fig. 45 and Fig. 46.

The following steps are necessary:

Step	Procedure
1	Install heat shield using Allen screw M5x12 with new lock washer A5. Tightening torque 6 Nm (53 in. lb.).

Graphic

Fig. 45

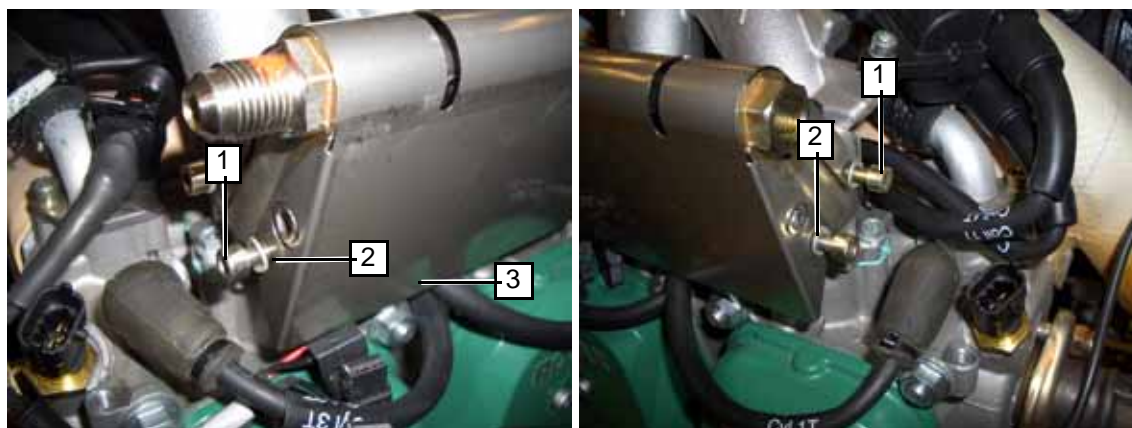

- 1 M5x12 Allen screw
- 2 Lock washer A5
- 3 Heat shield

Step	Procedure
2	Install the cover using M5x12 Allen screw and spring washer 12x5.2x0.5 part no. 939445. Tightening torque 5 Nm (44 in. lb.).

d05819.fm

SERVICE BULLETIN

Fig. 46

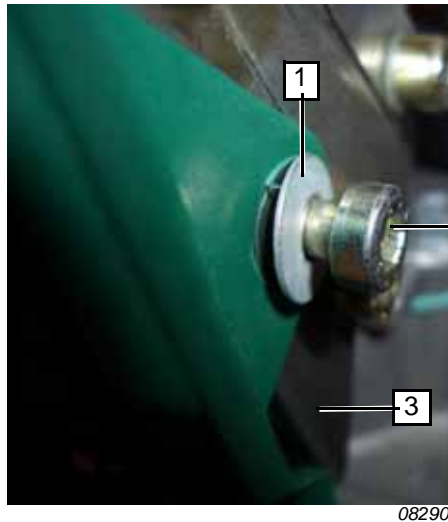

- 1 Spring washer 12x5.2x0.5
- 2 M5x12 Allen screw
- 3 Heat shield

08290

3.4.7) Installation of Fuel line assy.

See Fig. 47 to Fig. 50.

The following steps are necessary:

NOTICE

Before installing the fuel line assy., plug in EGT 1 and EGT 2 connector in the pre-assembled brackets of the intake manifold.

Graphic

Fig. 47



08291

08292

1 EGT bracket

NOTICE

Fit fuel line assy. tension-free. If the line is too far from the fuel rail, then the fuel line must be adjusted. The sealing surfaces must be parallel.

d05819.fm

SERVICE BULLETIN

Step	Procedure
1	Install the fuel line using banjo bolts onto the fuel rails left and right.
2	Install fuel line assy. on the propeller gearbox using cable clamp 8/M6 and M6x16 Allen screw with washer 6.4 (in the upgrade kit). Tightening torque 10 Nm (89 in. lb.).

Fig. 48

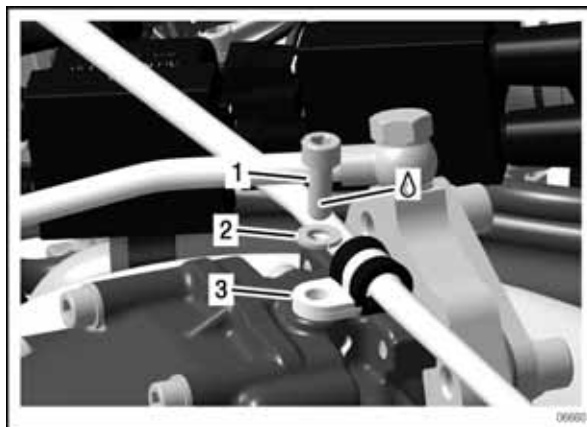

- 1 M6x16 Allen screw
- 2 Washer 6.4
- 3 Cable clamp 8/M6

Step	Procedure
3	Install and tighten the airbox on ignition housing using hex. nut M6 DIN 924 and washer 6.4. Tightening torque 10 Nm (89 in. lb.).

Fig. 49

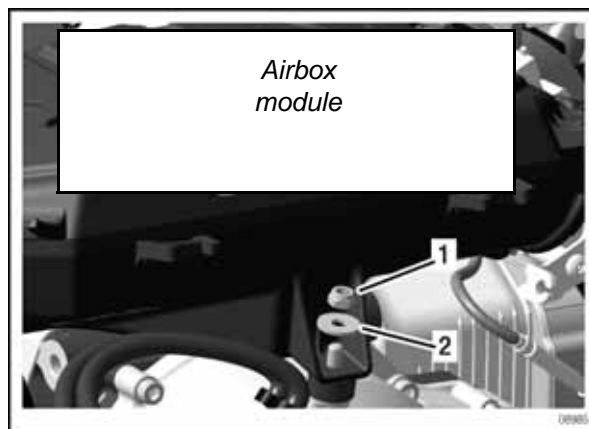

- 1 Hex. nut M6 DIN 924
- 2 Washer 6.4

Step	Procedure
4	Tighten the intake manifold 2/4, 1/3 from inside to the outside. Tightening torque 10 Nm (89 in. lb.).
5	Tighten 3 banjo bolts from the fuel lines. Tightening torque 25 Nm (221 in. lb.).

d05819.fm

SERVICE BULLETIN

Fig. 50

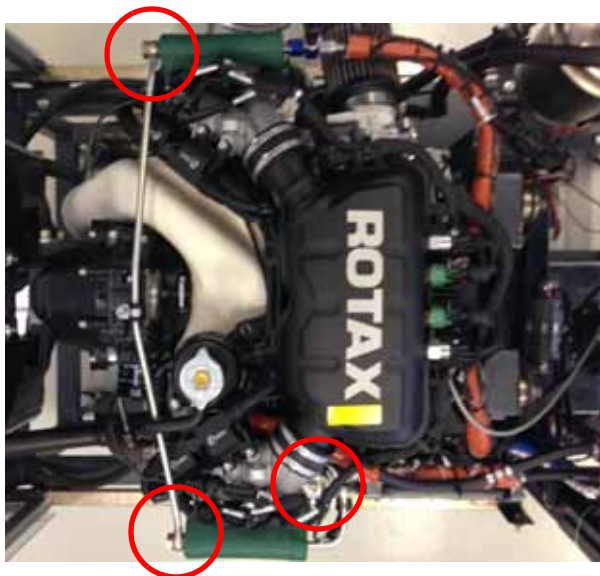

08293

3.4.8) Installation of Tube for the Fuel pressure regulator assy.

See Fig. 51.

The following steps are necessary:

Step	Procedure
1	Attach tube 60 (regulator/airbox) with 2 pcs. cable ties part no. 866718 (included in upgrade kit).

Graphic

Fig. 51

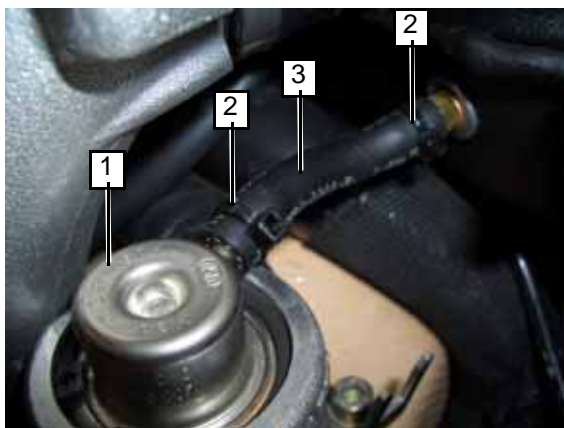

- 1 Fuel pressure regulator assy.
- 2 Cable tie 94x2.5
- 3 Tube 60

08294

3.4.9) Installation of the double Ignition coils

See Fig. 52 and Fig. 53.

NOTE: Double ignition coil 3 and 4 are with a Allen screw positioned. The second Allen screw is only slightly screwed into the thread.

d05819.fm

SERVICE BULLETIN

Step	Procedure
1	Plug in ignition coil connectors. The red cable to the positive (+) and the black cable to negative (-).

NOTICE

The older cable version of the 912 i Series had two red cables. The red cable with millimeter line = minus (-) pole.

NOTE: The ignition coils are marked with a Plus (+) and Minus (-).
RED= (+) BLACK = (-).

Graphic

Fig. 52

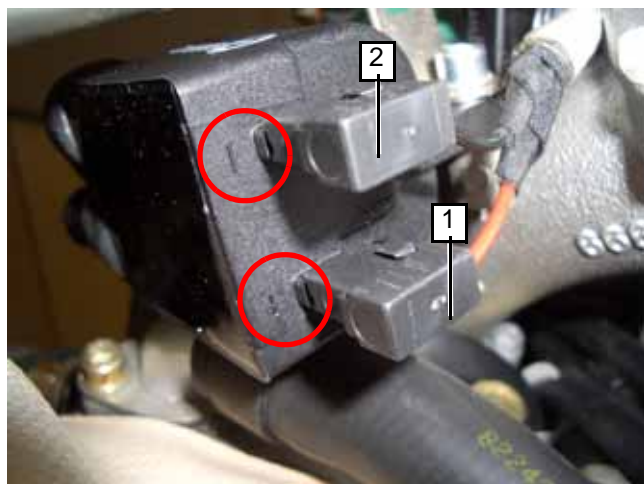

- 1 Ignition coil connector (red cable) Plus (+)
- 2 Ignition coil connector (black cable) Minus (-)
- 3 Double ignition coil

08295



08296



08297

NOTICE

The Allen screw that is turned completely in, must be secured with LOC-TITE 243, when attaching the double ignition coils. The function of the pre-coat coating does not work anymore.

d05819.fm

SERVICE BULLETIN

Graphic

Fig. 53

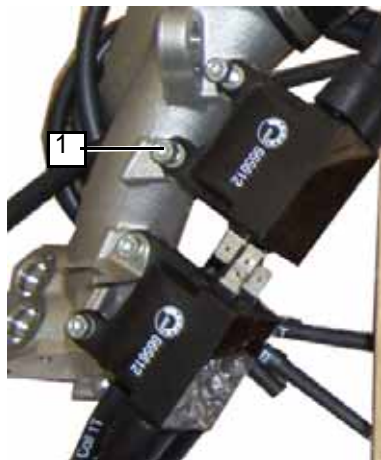

1 Allen screw

07920

Step	Procedure
2	Tighten double ignition coils using Allen screws. Tightening torque 6 Nm (53 in. lb.).

3.4.10) Installation of the Ignition cabling

See Fig. 54 to Fig. 55.

The following steps are necessary:

Step	Procedure
1	Secure the ignition cables from double ignition coil at cyl. 1 and 2 with cable ties part no. 866714 (included in upgrade kit).

Graphic

Fig. 54

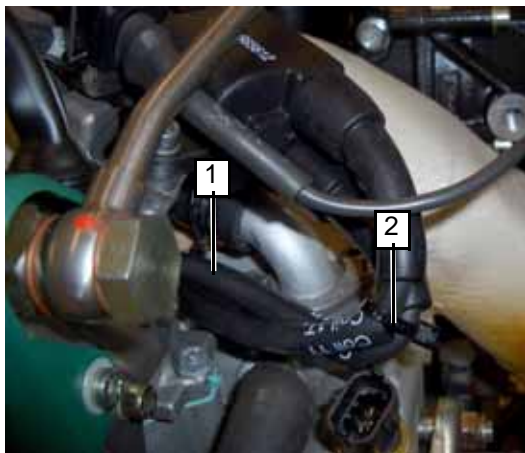

08298

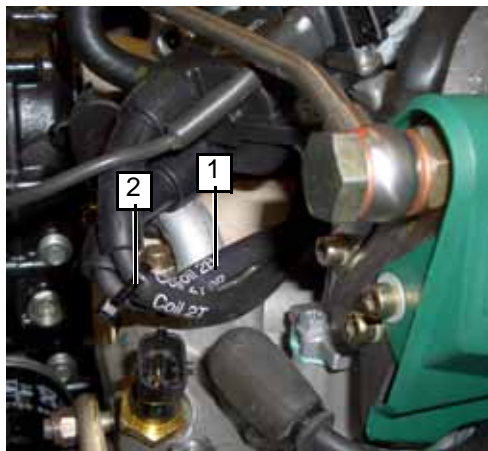

08299

1 Ignition cable assy.
2 Cable ties 94x2.5

d05819.fm

SERVICE BULLETIN

Step	Procedure
2	Check routing of ignition wires, may align if needed. Tighten the two cable ties on the airbox and cut them.

Fig. 55

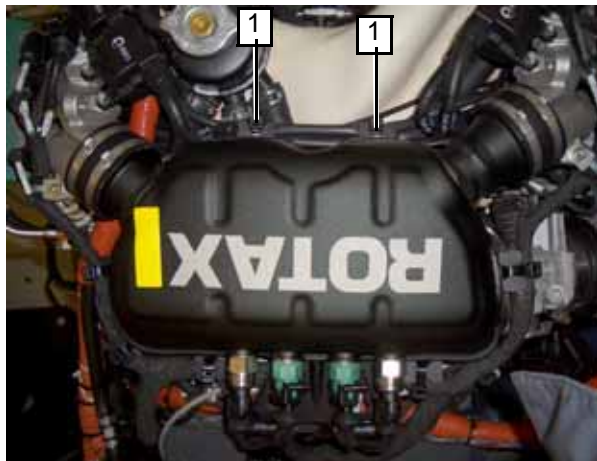

1 Cable ties

07905

3.4.11) Plug in Injectors

See Fig. 56.

The following steps are necessary:

NOTICE

Install cables stress-free!

Step	Procedure
1	Plug in injectors. NOTE: The cables are labeled from INJ_1 to INJ_8.

d05819.fm

SERVICE BULLETIN

Graphic

Fig. 56

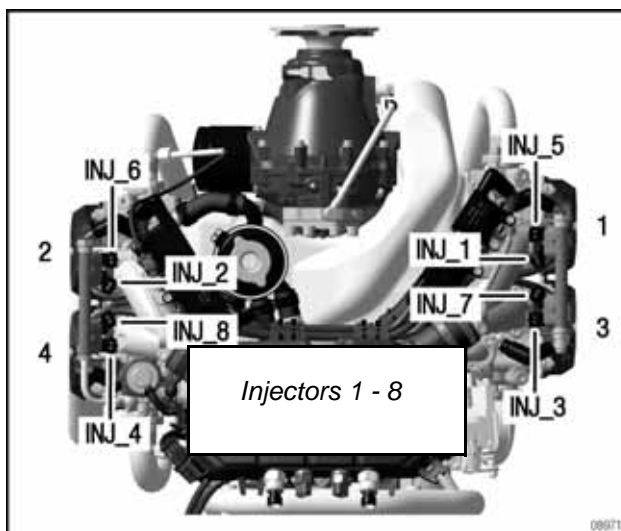

3.4.12) Installation of the Throttle body assy.

See [Fig. 57](#) to [Fig. 59](#).

Following parts are included in the upgrade kit:

- Part no. 850020 1 pcs. Rubber ring
- Part no. 440164 3 pcs. Hex./Torx-flange screw M6x16
- Part no. 953020 3 pcs. Separating plate

Graphic

Fig. 57



1 Hex./Torx-flange screw M6x16

09707

NOTE: When installing the throttle body, a new rubber ring has to be used!

SERVICE BULLETIN

Fig. 58

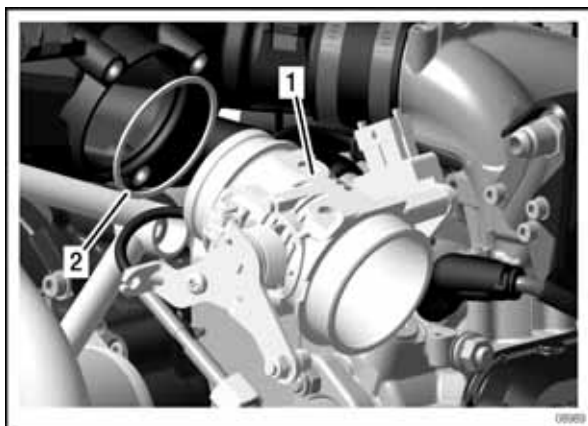

- 1 Throttle body
- 2 Rubber ring

NOTICE

The throttle body has a latching, it must engage in the airbox latching recess.

Fig. 59



09708

- 1 Airbox latching recess
- 2 Throttle body latching



09709

The following steps are necessary:

NOTICE

Check if the latching snaps into the recess of the airbox.

Step	Procedure
1	Install the rubber ring. NOTE: Rubber ring should be installed dry!
2	Push the throttle body into the airbox. Tighten 3 pcs. hex./torx-flange screws M6x16 and the separating plate. Tightening torque 8 Nm (71 in. lb.).

d05819.fm

SERVICE BULLETIN

Fig. 60

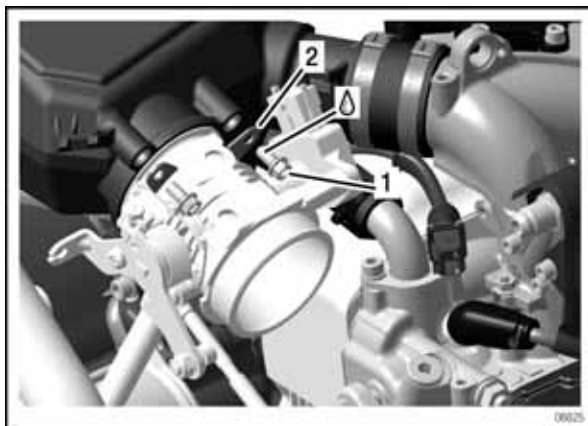

- 1 Hex./Torx-flange screw M6x16
- 2 Separating plate

Step	Procedure
3	Plug in connector (1) from the throttle potentiometer..

Fig. 61



- 1 Connector - throttle potentiometer

09711

3.4.13) Installation of the Airbox temperature sensor and the Pressure sensor

See Fig. 62 and Fig. 63.

Following parts are included in the upgrade kit:

- Part no. 651780 1 pcs. Connector bracket
- Part no. 866714 5 pcs. Cable ties 142x3.2

The following steps are necessary:

NOTICE

Danger of too lean mixture!
Secure threaded temperature sensor with LOCTITE 243, otherwise external air can get into the airbox.

d05819.fm

SERVICE BULLETIN

Step	Procedure
1	Clean the thread of the temperature sensor.
2	Lubricate the thread of the temperature sensor with LOCTITE 243 and use an SW 19 open-ended spanner part no. 876130 (or a similar tool) to tighten it. Tightening torque 10 Nm (89 in. lb.). NOTE: Installation of aluminum washer is not required.
3	Plug the respective wiring harness connector into the corresponding temperature sensor.

Fig. 62

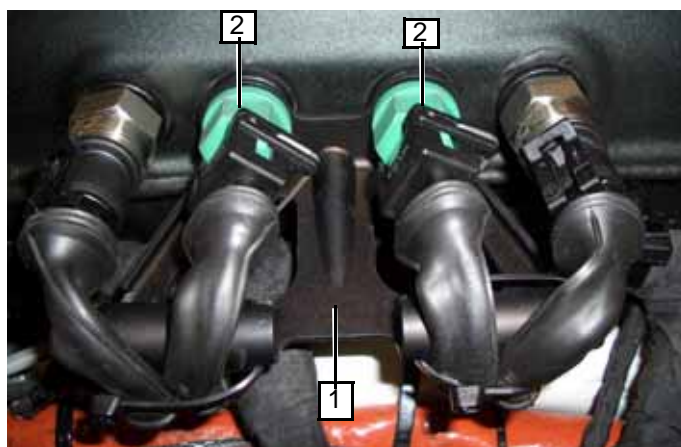

1 Connector bracket
2 Temperature sensor

09713

Step	Procedure
4	Clean the thread of the pressure sensor.
5	Tighten pressure sensor using a wrench SW 21 part no. 876075 (or a similar tool). Tightening torque 15 Nm (133 in. lb.).
6	Plug the respective wiring harness connector into the corresponding pressure sensor.
7	Attach the cables of the temperature and pressure sensor with 2 cable ties part no. 866714.

d05819.fm

SERVICE BULLETIN

Fig. 63

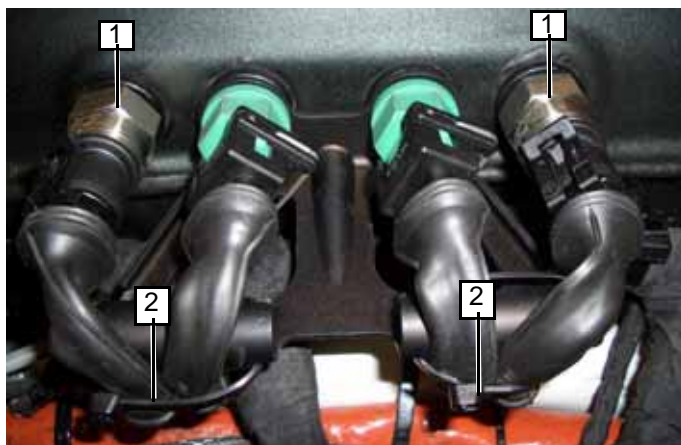

1 Pressure sensor
2 Cable ties

09713

3.4.14) Installation of the Plug connector for speed and Knock sensor

See Fig. 64.

The following steps are necessary:

Step	Procedure
1	Press the connector into the pre-assembled connector bracket.
2	Fix the cable with 3 cable ties so, that the cables could not scrub or be damaged.

Graphic

Fig. 64

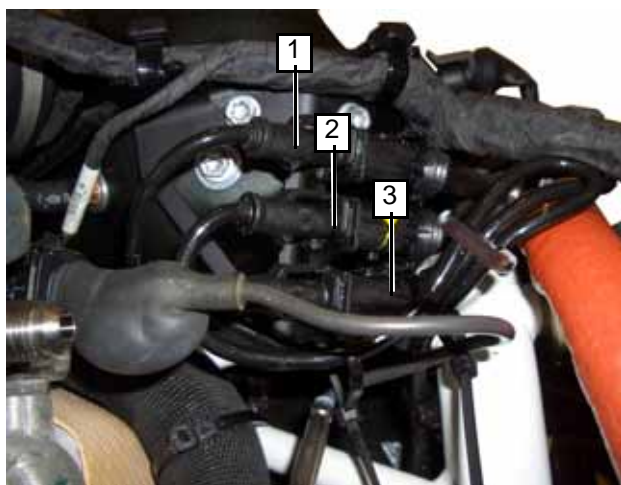

1 KNOCK
2 CPS_1
3 CPS_2

09714

3.4.15) Installation of the Wiring harness on the airbox

See Fig. 65 to Fig. 67.

The following steps are necessary:

NOTICE

Due to the enlarged volume of the 912 iS Sport airbox, the complete construction is higher. Pay attention to the correct routing of the wiring harness!

d05819.fm

SERVICE BULLETIN

Step	Procedure
1	Install the wire harness with cable clamps and cable ties without mechanical stress.
2	Check that all plug connections are secure, contacted and free from corrosion and dirt.
3	Check the grounding for good contact and cleanliness.

Graphic

Fig. 65

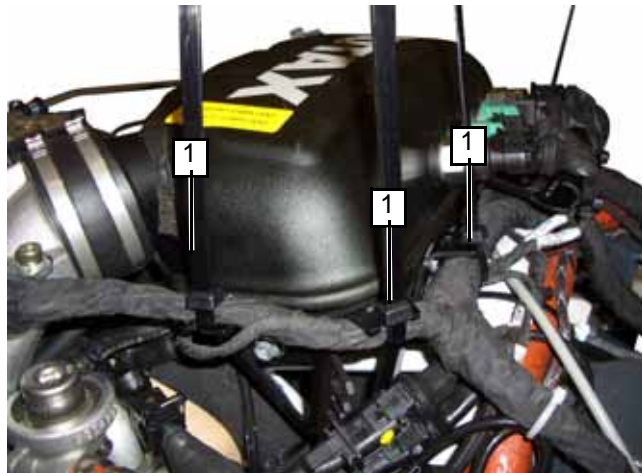

1 Cable ties

07915

Fig. 66



1 Cable ties

07916

d05819.fm

SERVICE BULLETIN

Fig. 67



1 Cable ties
2 Cable clamp

07917

3.4.16) Installation of the Type plate

The following steps are necessary:

Step	Procedure
1	Please take note, that the engine number and the engine type on type plate agrees completely.
2	Installation of the type plate on the crankcase in riveted assembly. NOTE: New rivets must be used.

d05819.fm

SERVICE BULLETIN

3.4.17) Finishing work

See Fig. 68.

NOTICE

The connection for the overflow bottle is hampered by the higher intake manifold.

NOTICE

To prevent problems with vapour formation, all the fuel lines must be insulated against heat in the engine compartment, routed at distance from hot engine components, without kinks and protected appropriately.

Step	Procedure
1	Install the fuel lines in accordance with the aircraft manufacturer.
2	Install the return fuel lines in accordance with the aircraft manufacturer.
3	Install the air filter or air intake hose in accordance with the aircraft manufacturer.

Fig. 68

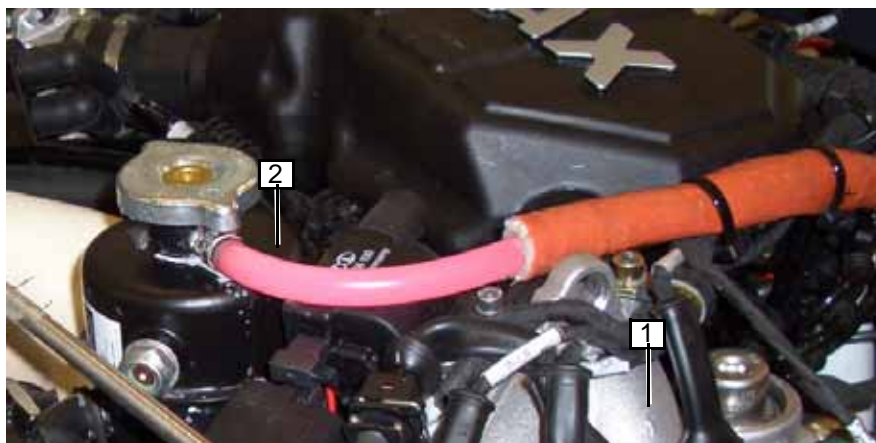

1 Intake manifolds
2 Expansions tank

07921

d05819.fm

SERVICE BULLETIN

3.5) Flashen of the ECU from 912 iS to 912 iS Sport

WARNING

Non-compliance with these instructions could result in engine damages, personal injuries or even fatal injury!

Only a ECU with ROTAX® part no. 665568 (or explicitly by ROTAX® released ECU versions) is allowed to be used in combination with Engines of the Type 912 iS Sport. Running a 912 iS Sport engine by using a ECU with deviating ROTAX® part no. will cause significant engine damage.

NOTICE

The removal and installation must be done according to the the relevant Maintenance Manual. In addition observe the specification of the aircraft manufacturer.

NOTICE

The ECU can also be adapted while implemented in an Aircraft. Please contact your ROTAX® authorized distributor.

The following steps are necessary to flash the ECU:

Step	Procedure
1	Disconnect ECU from engine wiring harness and remove it from the aircraft.
2	Send ECU to ROTAX® authorized distributor.
3	The flashing process of the ECU software is carried out by a ROTAX® authorized distributor.
4	The ECU will be returned from the ROTAX® authorized distributor and has to be installed as specified by the aircraft manufacturer and described in the latest Maintenance Manual.

SERVICE BULLETIN

4) Appendix A: Checking of the overload clutch

General In the event of lead deposits and/or if slipping is suspected, it will be necessary to check the overload clutch.

NOTE: Slipping of overload clutch is apparent if at engine speed rise, the propeller speed does not increase at the same rate.

NOTE: The engine should be run for a short time just prior to the test, otherwise there is the risk of the clutch “drying out“, resulting in a higher torque.

Step	Procedure
1	Remove the propeller as per manufacturers instruction.
2	Lock the crankshaft. See Maintenance Manual Line chapt. 12-20-00 section: 6)
3	<div style="display: flex; align-items: flex-start;"> <div style="background-color: #0070C0; color: white; padding: 5px; margin-right: 10px; text-align: center;">NOTICE</div> <div> <p>Danger of damage to the engine suspension! Depending on the engine installation (e.g. in the case of extremely lightweight engine suspension), the gearbox must be removed and the test carried out on a suitable mounting attachment.</p> <p>Install a torque multiplier of respective specification (1000 Nm /737.6 ft.lb.) on the propeller flange.</p> <p>NOTE: Because of difficult measurement of the slipping torque the braekaway torque is measured.</p> </div> </div>
4	<p>Attach and adjust outrigger of the torque multiplier. If the engine is mounted in an aircraft, this one must be supported/fixed to the ground.</p> <p>NOTE: The effective direction of the support device is opposite to the input direction of rotation.</p>
5	Connect torque wrench to torque multiplier.

d05819.fm

SERVICE BULLETIN

Fig. 69

10202,10201

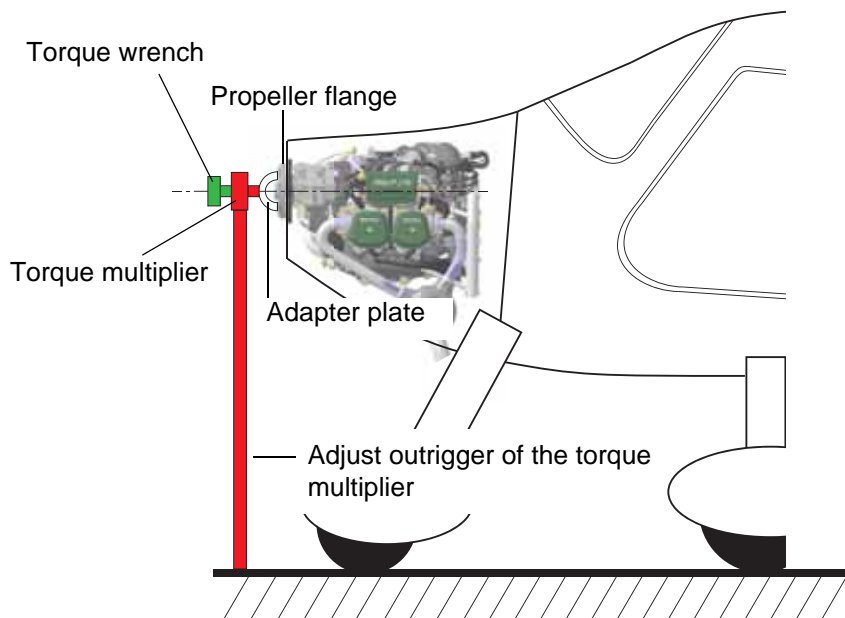
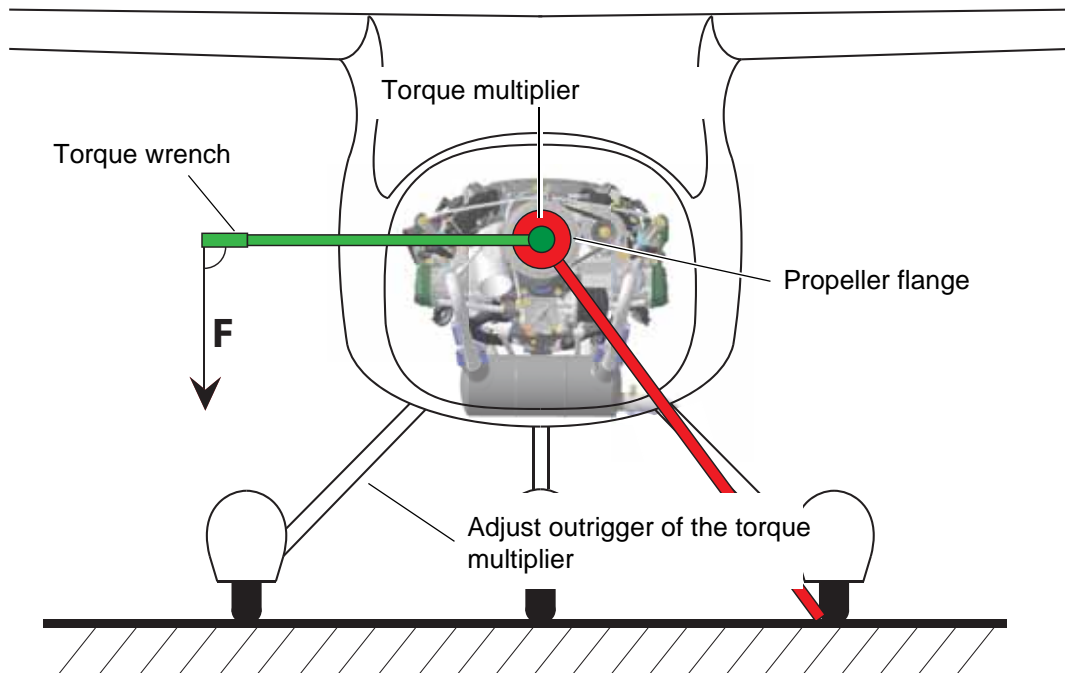

d05819.fm

SERVICE BULLETIN

Step	Procedure
6	Turn over the clutch for 3 times. (No record of measured values!)
7	Inspect the breakaway torque with a torque wrench. NOTE: Check transmission ratio of the torque multiplier. The measurement must be repeated a few times (min. 2x) in order to obtain a stable value.
8	Compare the measured value with the limits in table 1. NOTICE The maximum limit must not be exceeded, otherwise it may cause a damage of the gearbox. Values below the minimum limit may cause a slipping of the overload clutch that result in an overspeed. If the value is greater or smaller than the limit values, the overload clutch must be inspected, repaired or overhauled in accordance with the BRP-Powertrain instructions for continued airworthiness.

Table 1.

Motortype	minimum Limit	maximum Limit
912 iS/iSc	600 Nm (442 ft.lb.)	800 Nm (590 ft.lb.)
912 iS/iSc Sport	700 Nm (516 ft.lb.)	900 Nm (664 ft.lb.)

Step	Procedure
9	Remove torque multiplier and torque wrench.
10	Release the crankshaft, see Maintenance Line chapt. 12-20-00 section: 6).
11	Install the propeller according to the manufacturers instruction.

- Restore aircraft to original operating configuration.

4.1) Test run

Conduct test run. See also chapter 12-20-00 current issue Maintenance Manual Line of the engine type 912 i Serie.

4.2) Summary

These instructions (section 3) have to be conducted in accordance with the deadlines from section 1.5. The execution of the optional Service Bulletin must be confirmed in the logbook.

Approval of translation to best knowledge and judgement-in any case the original text in German language and the metric units (SI-system) are authoritative.

d05819.fm

SERVICE BULLETIN

4.3) Enquiries

Enquiries regarding this Service Bulletin should be sent to the ROTAX® authorized distributor of your area.

A list of all distributors is provided on www.FLYROTAX.com.

NOTE:

The illustrations in this document show a typical construction. They may not represent full detail or the exact shape of the actual parts but have the same or similar function.

Exploded views are **no technical drawings** and are for reference only. For specific detail, refer to the current documents of the respective engine type